

本体寸法		枠外寸法	
W	H	W	H
610	2032	1232	2077
661	2032	1334	2077
711	1778	1434	1823
711	2032	1434	2077
762	2032	1536	2077
813	2032	1638	2077
914	2032	1840	2077

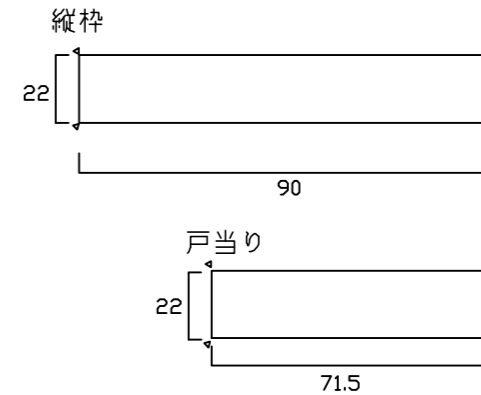

見込サイズ 90mm

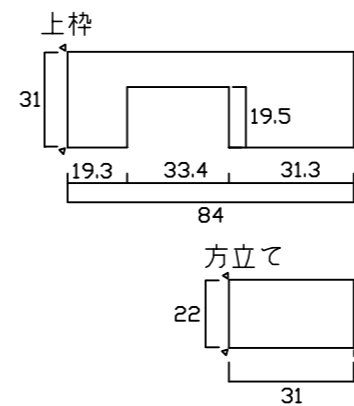
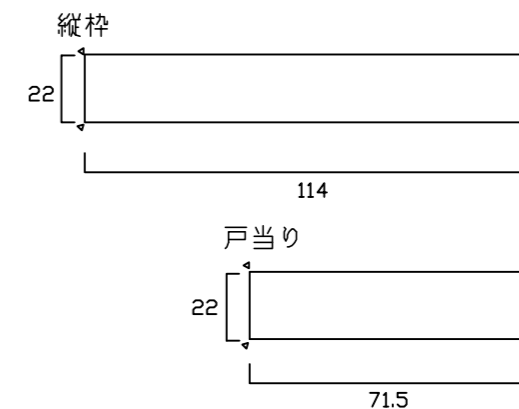
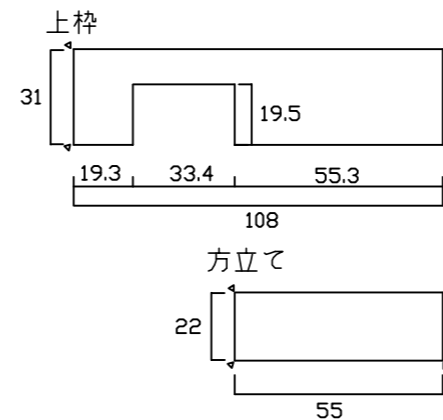

見込サイズ 114mm

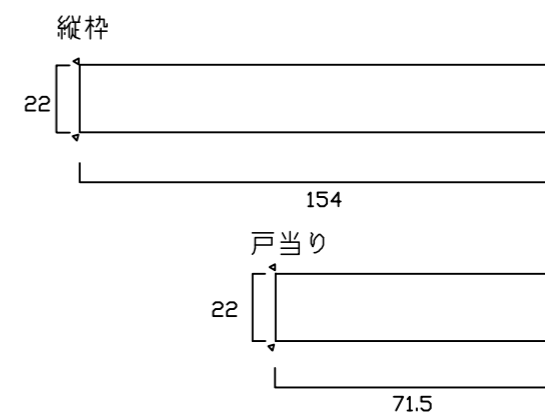
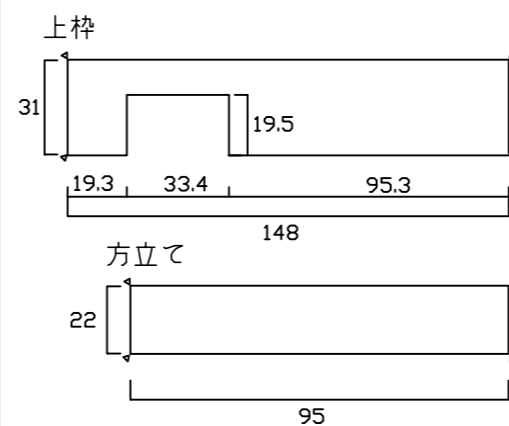

見込サイズ 154mm

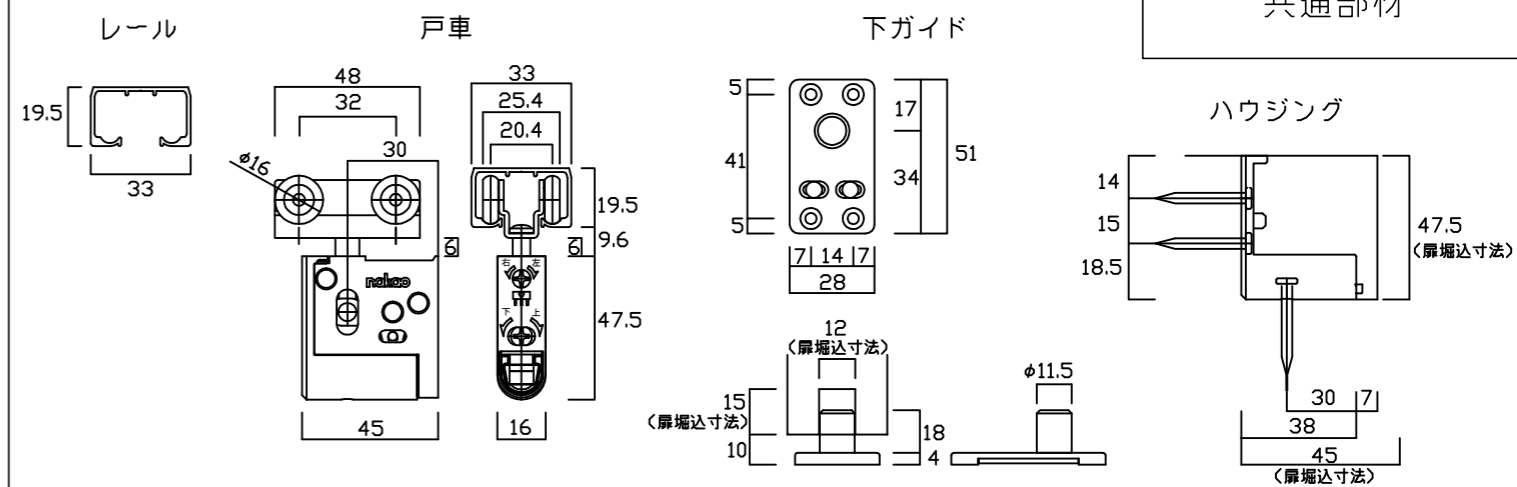

共通部材